

Your Global Automation Partner

# TURCK

## RFID Solutions for the Automotive Industry



Product pictures are linked with further information

# Modular RFID System BL ident®

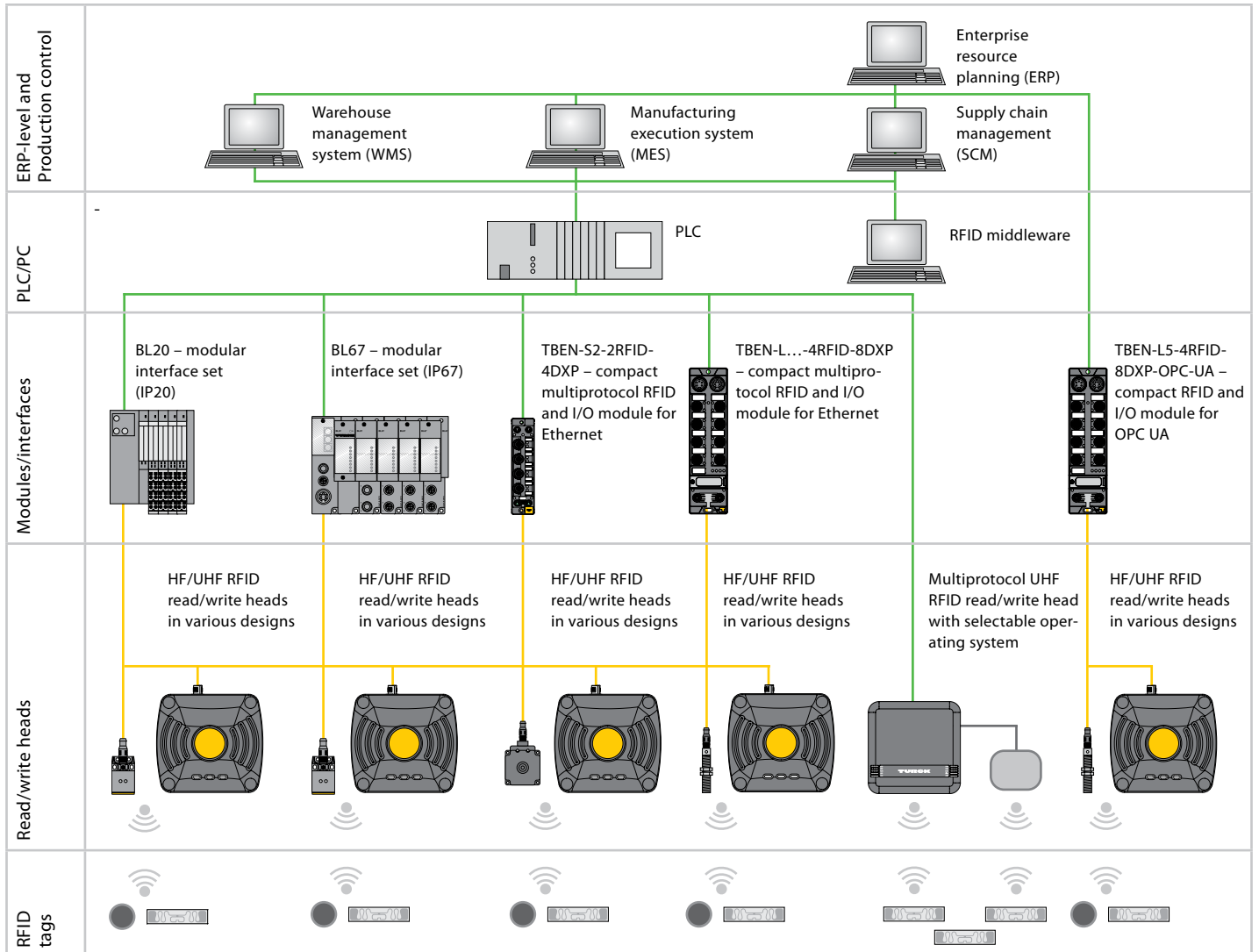

BL ident® is an all-in-one modular RFID system that is ideally suited for the automotive industry, among others. The system is based on the TURCK I/O systems BL67 (field application) and BL20 (cabinet mounting) plus the compact fieldbus modules TB...-L... and TB...-S... (field application). BL ident® enables you to use HF technology (13.56 MHz, in accordance with ISO 15693) and UHF technology (865...928 MHz, in accordance with ISO 18000-6C/EPCglobal Class 1 Gen 2) in parallel. Each BL ident® system can be created from tags, read/write heads, connectivity and interfaces (gateway and RFID modules) as needed to form a tailor-made

identification solution that can be easily integrated into your plant configuration via gateways for all common fieldbus protocols or into a higher-level system via OPC UA. Up to 32 bus-compatible read/write heads arranged in line topology can be connected to a single interface channel, making this system a particularly cost-effective solution for non-time-critical applications such as the identification of machine parts.





Programmable interfaces can perform control tasks, such as the monitoring of drying or cooling times and the reporting of undershoots, in a decentralized manner.

The product range of the tags is supplemented by special versions for high temperatures, for installation on and in metal, and with sensor functions.

The BL ident® system is wear-free and contactless, is resistant against temperature fluctuations, dirt and fluids, and has an extremely long service life. Using international standards that are applicable worldwide makes the system future-proof and interoperable.

Application examples on the reverse side show these products in use





## Read/write heads

Type designation	Dimensions	Description
 TN-Q14-0.15-RS4.47T	52 x 30 x 14 mm	HF technology, compact
 TNLR-Q80-H1147	114 x 65 x 40 mm	HF technology, long range
 TNSLR-Q80WD-H1147	102 x 83 x 40 mm	HF technology, IP69K protection rating, very long range
 TNLR-Q80L400-H1147	400 x 80 x 25 mm	HF technology, wide design to cover a larger area or high speeds

Type designation	Dimensions	Description
 TN865-Q120L130-H1147	130 x 120 x 60 mm	UHF technology, compact
 TN865-Q175L200-H1147	200 x 175 x 60 mm	UHF technology for long ranges
 TN-UHF-Q300-EU-CDS	300 x 300 x 61.7 mm	UHF technology for long and very long ranges, can be extended using passive RFID antennas, can be programmed with CoDeSys

## Tags

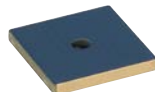
Type designation	Dimensions	Description
 TW-BS10X1.5-19-K2	M10, Ø 17.5 mm	HF tags in screw design
 TW-R30-K9 and DS-R30 (spacer)	Ø 30 mm	HF standard tag
 TW-R50-B128 and DS-R50 (spacer)	Ø 50 mm	HF standard tag
 TW-Q51WH-HT-B128 and TH-Q51T-HT (mounting aid)	51 x 51 mm	HF tag for cyclic high temperature load up to 240 °C, suitable for applications in paint shops

Type designation	Dimensions	Description
 TW-L86-54-C-B128	86 x 54 x 0.8 mm	Credit-card-sized HF tag
 TW860-960-L73-17-B38/C49	73 x 17 mm	UHF smart label made of printable white polypropylene for temperature loads up to 150 °C
 TW860-960-Q27L97-M-B112	97 x 27 x 15 mm	UHF tag for mounting on metal
 TW865-868-Q28-M-HT-B210 (ETSI) TW902-928-Q28-M-HT-B210 (FCC)	28 x 28 x 4 mm	UHF tag for high temperature loads, suitable for applications in paint shops
 On request	5.1 x 3.1 x 5.7 mm	UHF miniature tag for mounting on or in metal

# RFID Solutions for the Reliable Identification of:

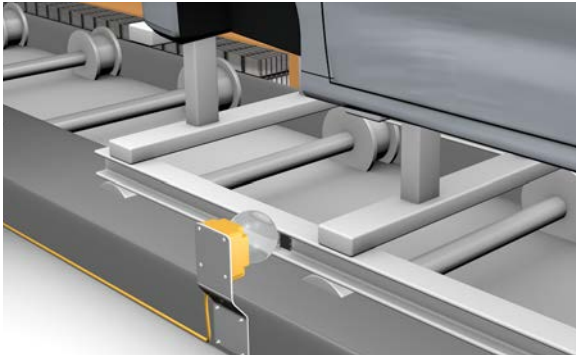

## Skids in body and paint shops

- Avoid production errors by reliably tracking skids through the entire production process
- The high-temperature tags withstand the high temperatures that can occur in paint shops

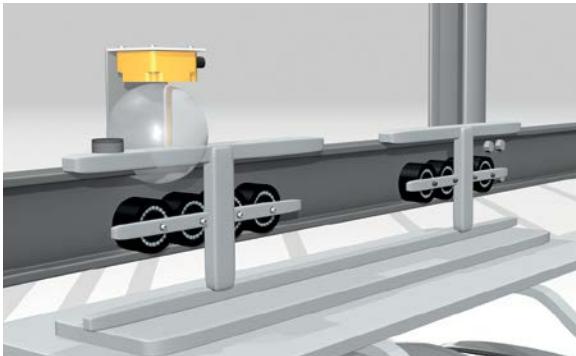
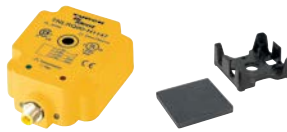

## Skids in final assembly

- Control production effectively by reliably identifying overhead conveyors
- Standard tags are mounted on metal using a spacer

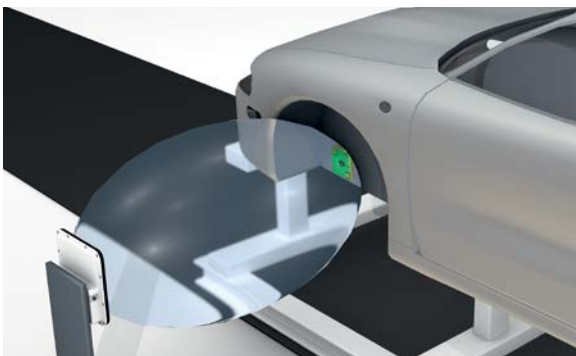

## Car bodies

- Reliably track the car body through the entire production process
- The high-temperature tags withstand the high temperatures that can occur in paint shops
- The UHF tag stays on the car and can also be used during the subsequent logistics applications



## Cars during shipping

- Avoid erroneous deliveries by securely assigning each car to a particular area of the parking lot
- Cars can be identified by means of tags on the body, which were also used in production



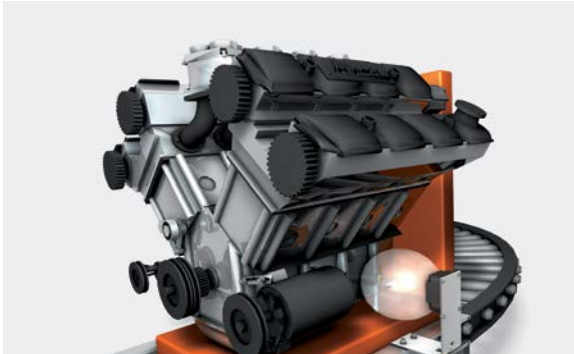

### Engine and gearbox types

- Automate and avoid errors in assembly and disassembly processes on the engine or gearbox housing through automatic assignment of gearbox types
- Robust tag in screw design

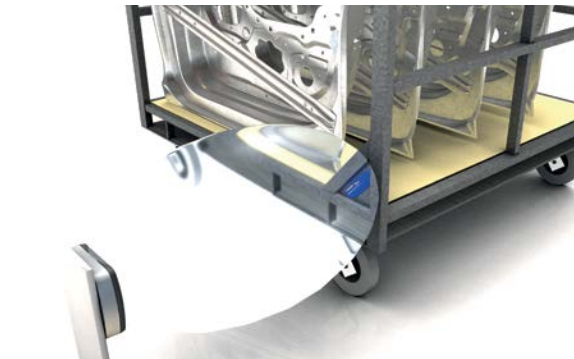

### Transport containers at packaging carriers

- Reliably control transportation processes during car assembly
- Information about the car parts is stored on the tag

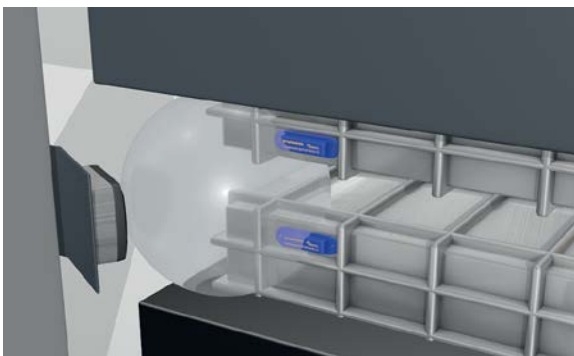
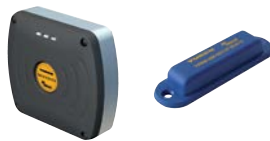

### Pressing tools

- Avoid crashes and downtimes by reliably identifying pressing tools
- Simultaneously identify lower and upper tool parts



### Machine operators

- Individual authorization/access control of the plant
- More secure than PIN code, which could be spied out and used by unauthorized persons.





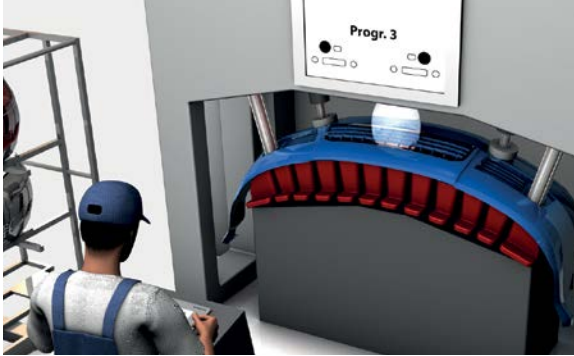

## Bumpers in production

- Identification of each bumper enables automatic recognition during subsequent processing steps
- A manual scan is no longer required
- UHF smart labels are glued directly in the bumper

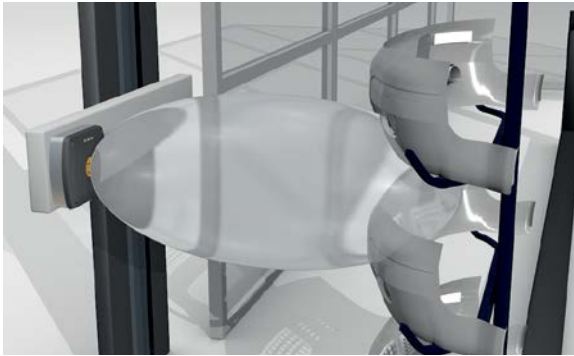

## Bumpers in storage containers

- Production is highly efficient thanks to permanent tracking of the storage containers and automatic initiation of their removal
- UHF smart labels are glued directly in the bumper

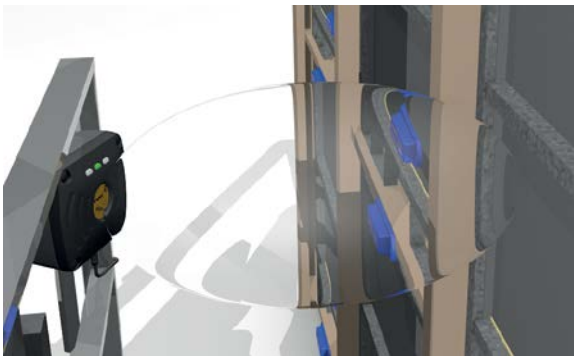

## Storage containers in high-bay warehouses

- Protect against incorrect storage by simultaneously identifying the storage container and the storage location
- Tag is suitable for direct mounting on metal on the shelf



## Trays for connectors

- Ensuring a sufficient dwell time during cooling through automatic monitoring of the cooling time
- Decentralized solution functions even without connection to a controller



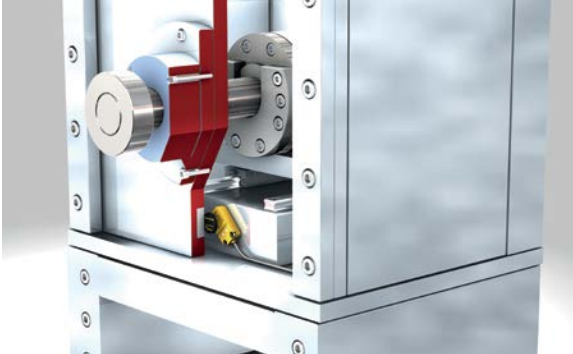

## Machine tools

- Flexible concept can be used for identifying tools and their use
- RFID-based tool identification prevents production errors resulting from using incorrect tools and increases machine availability
- The production tolerances stored in the tool allow it to directly verify the product on the machine

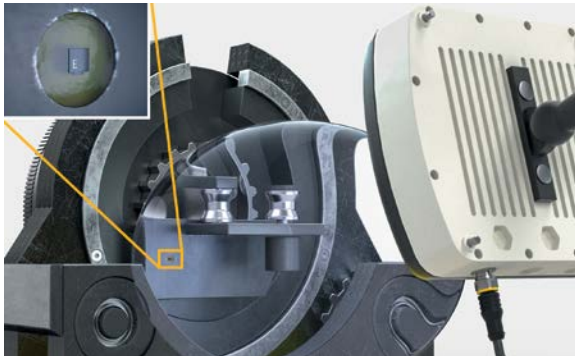

## Tools for remote use

- Avoid production errors by reliably identifying the correct tools and their attachments
- Ensure that the correct tool is used for the production task
- Miniature UHF tags can be used for mounting on or in metal



## Product carriers for car seats

- Error-free just-in-sequence production and clear traceability enabled through the reliable identification of car seats
- Clear type and status identification in the tag in the product carrier

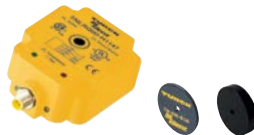

## Car parts at item level

- Ensure reliable and cost-effective identification of parts by using UHF near-field antennas
- UHF labels are glued directly on the part
- Commissioning is simple using Power over Ethernet and an integrated interface



# Identification Solutions for the Automotive Industry

Innovative solutions for the automotive factory of today and tomorrow

With the variety of cars produced increasing, there is also growing pressure on manufacturers and suppliers to keep production costs low or even to reduce these costs further. On top of this, components must be traceable. Tailor-made RFID solutions help to increase process reliability, transparency and efficiency, thus preparing automotive production for the future.

Turck offers RFID solutions that can be used to identify:

- Cars and skids
- Components to be installed or already installed
- Transport and storage containers
- Production equipment such as pressing tools

Tailor-made products for the automotive industry

- Extensive portfolio of RFID tags that are optimized for specific applications, e.g. for the high temperatures in paint shops
- Read/write heads in various designs for a wide range of mounting and application requirements
- Future-proof communication standards such as OPC UA for Industry 4.0

Realization of turnkey solutions

From designing processes to selecting the correct tags – our RFID experts are there to help. A successful RFID project starts with a site analysis carried out by our specialists. This is followed by our 5-step model for success and – upon request – we provide 24-hour support to ensure smooth operation. Our experience ensures your success.

## Consulting — Service — Support

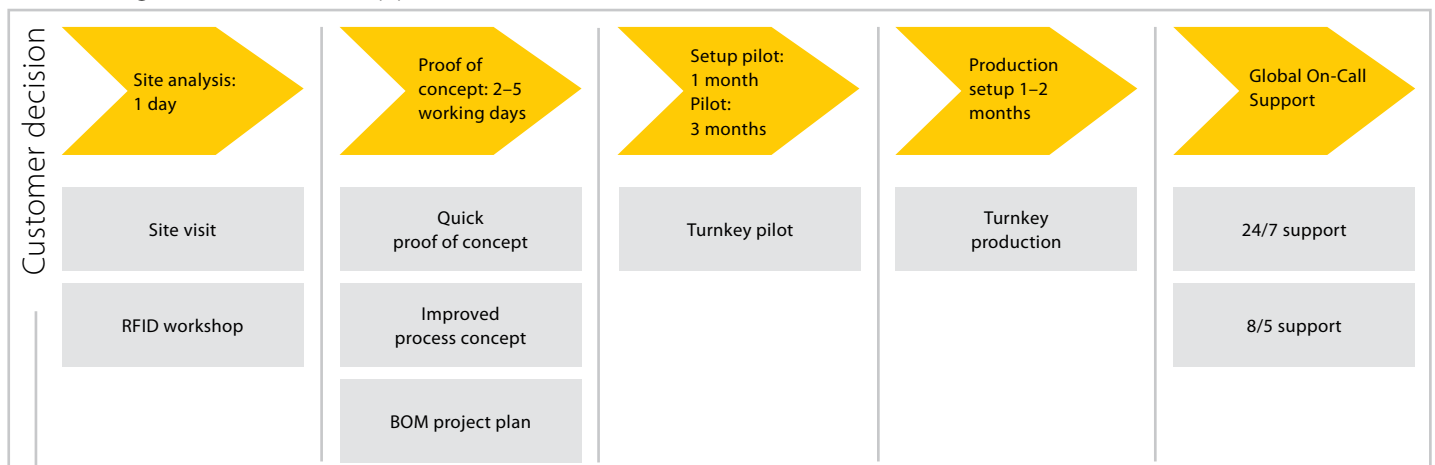

Over 30 subsidiaries and 60 representatives worldwide!

